



AMK Commercial Series

## QSA 615-EPS

Self Amplified 6.5" Coaxial Loudspeaker Assembly



The **AMK QSA615-EPS** powered speakers feature a 15 watt Class D digital design amplifier, with > 75% efficiency for the main speaker. This unit is a quarto system of 4 speakers, one powered speaker and three companion speakers. The speaker combines high performance, power handling, and a very smooth response.

The loudspeaker driver, CX602, is one of the few transducers in the commercial sound industry that produces and meets the standards of recording studio. Excellent dispersion, wide bandwidth, and a smooth frequency response make this the top choice for today's overhead commercial applications.

There are wide ranges of the application for this unit, especially in educational markets and corporate boardrooms where direct input of the signal from the processor is desired (i.e., projectors, laptops, or any line level device)

### Features:

- \* All metal construction, including baffle
- \* High performance 6½" coaxial loudspeaker with wide dispersion
- \* Self powered with 20 watt Class D amplifier
- \* **UL Listed (UL 1480, UL 2043) PK-213-6 Enclosure**

## Innovative Features

Each system includes a renowned AMK Coaxial loudspeaker like those already installed in hundreds of locations

### Easy to install

- All-metal swivel mounting system allows standard installation of speakers without having to align the enclosure to the tile bridge
- This installation procedure is quick and unique to the industry
- Architecturally pleasing white perforated metal grille that uses a unique metal spring system for a "no visible hardware finished look and the ease of a "snap on" installation

### Custom Manufacturing Options

- Custom depth back enclosures are available
- Power supply available internal or external

### Safety

- The use of all-metal attachment parts makes for an overall safer installation
- All-metal swivel prevents breakage of swivel during installation
- All-metal swivel mounting system is not easily compromised by fire

### Sound

- The plenum compatible back enclosure is designed to maximize the performance of this studio quality speaker

## Specifications

Frequency Response	65 Hz - 20 kHz
Voice-coil diameter	1"
Average Beamwidth @ 2 kHz	144 deg.
Magnet Weight	13 oz
Magnet Material	Barium Ferrite
Tweeter	13mm Polyamide Soft Dome
Woofer Cone	Polypropylene
Surround Material	Inverted Rubber
Crossover Frequency	5.0 kHz
Depth of the Enclosure	10 in.
Diameter of the Grille	12.75 in.
Enclosure Mounting	Metal Swivel Clamp

## FREQUENCY RESPONSE

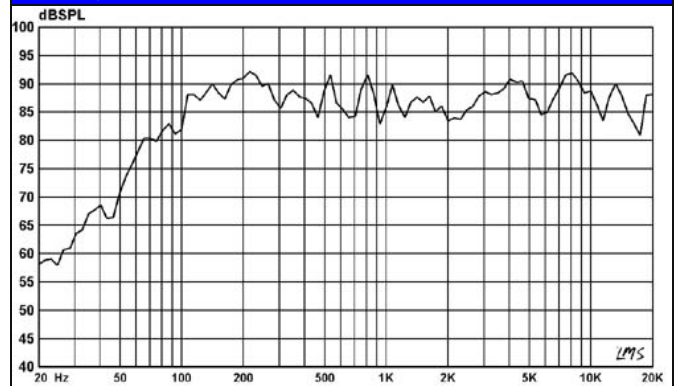

## IMPEDANCE CURVE

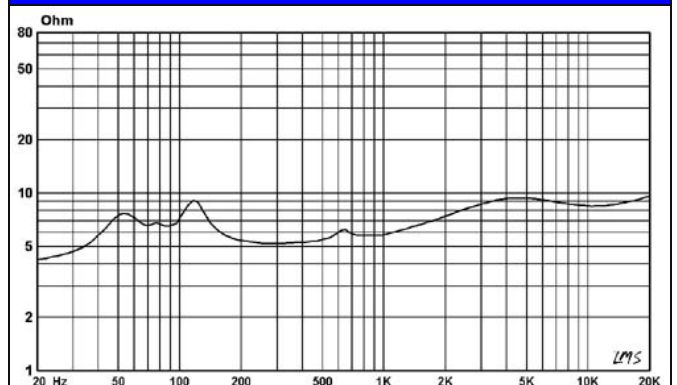

## Amplifier Specifications

Amplification	15 watt Class D design amplifier
Amplifier Efficiency	> 75%
Total Harmonic Distortion	< 0.2%
Signal to Noise Ratio	>95dB
Protection	Protected as to short circuit to supply and ground, as well as minimum current
Controls	Input potentiometer level adjustment

## MODEL CONFIGURATION

Two RCA phono jacks  
(stereo to mono unbalanced)

Screw terminal block  
connectors for companion  
speaker connection

3.81mm two position  
Phoenix type connector  
for 12volt 1.5A power  
input

Screw terminal block  
connectors for signal from  
amplified speaker

Seismic  
metal  
strap

Input level  
adjustment

Seismic  
metal  
strap

The speaker comes  
**WITHOUT** a power  
supply. User has an  
option for power  
source.

**Powered Speaker**

**Companion Speaker**  
(3) units are included

<b>Power Supply</b>	12 Volt for external higher amperage multi unit supply (User option for power source)	<b>Signal Input</b>	Stereo to Mono Unbalanced
<b>Power Connection</b>	3.81mm two position Phoenix type connector	<b>Companion speaker input/output connections</b>	Screw terminal block connectors
<b>Input Connection</b>	Two RCA phono jack	<b>Input Level Adjustment</b>	Internal
<b>Additional Suffixes</b>	The part numbers listed include the <b>TB8R</b> for use with suspended ceilings and speaker Grills For hard lid applications please add either of the following at no additional charge:- <b>SACSD</b> for the metal C ring for retro fit applications. - <b>MD8</b> For the pre-construction mud ring.		

## Wiring Diagram

All the speakers are connected in parallel

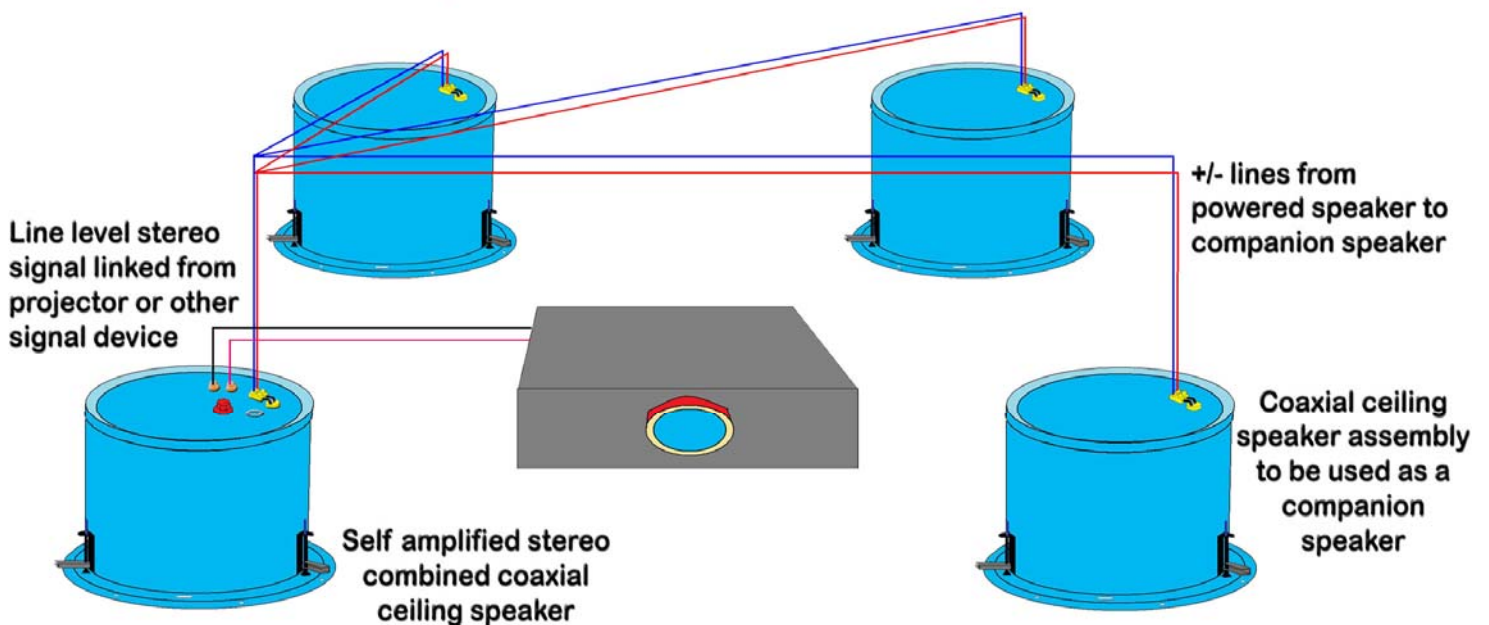

# QSA 615-EPS ILLUSTRATION

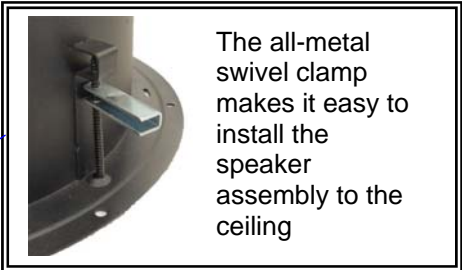
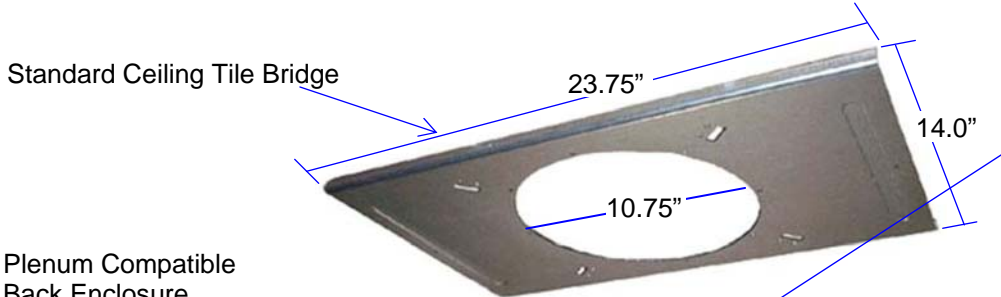

Plenum Compatible Back Enclosure  
**NFPA-70** National  
Electric Code, **UL 1480**  
and **UL 2043**, Speakers  
for Fire Protective  
Signaling Systems

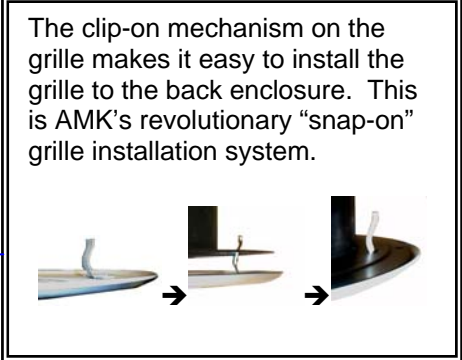
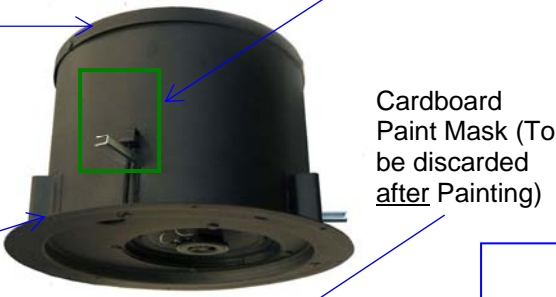

Guide for alignment of enclosure to tile bridge for grille installation

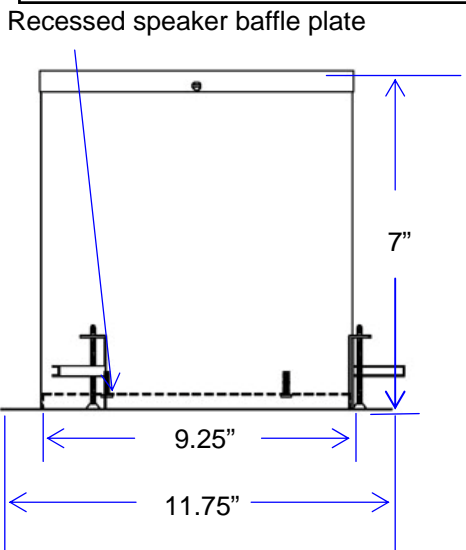

White Perforated Metal Grille

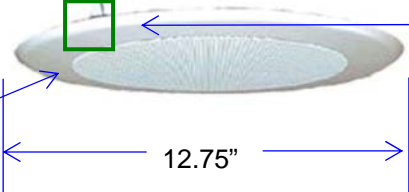

## Architect's & Engineer's Specifications

## Polar Responses

The powered loudspeaker system shall be **AMK QSA 615-EPS**. The speaker shall feature a 15watt Class D design amplifier, with >75% efficiency for the speaker. The powered speaker assembly in the system shall be of the coaxial type with an 6.5" woofer of polypropylene, an inverted rubber surround, and a 1" polyamide soft dome tweeter mounted on a post. The loudspeaker system shall have a white metal round grille that screws into the rim of the mounting enclosure. The system shall have input potentiometer for level adjustment.

The transducer in the loudspeaker system shall be AMK CX 602 coaxial loudspeaker. The woofer shall have a 13 oz. (369g) Barium Ferrite magnet. The two reproducer sections shall be coupled through a built-in capacitor bypass crossover. The crossover frequency shall be at 5.0 kHz. The low frequency reproducer shall have 1" (25.4mm) voice coil and the high frequency reproducer shall have 0.51" (13mm) voice coil.

The system shall have a frequency response of 65 Hz- 20 kHz (+/- 5dB). The power handling shall be 25watts at 4 ohm impedance. The sensitivity shall be 91dB at 1watt / 1meter.

The rim diameter shall be 11.75". The enclosure diameter shall be 9.25". The depth of the enclosure shall not exceed 11.75". The system shall include a tile bridge. The system shall have a metal strap for attachment to the structure for seismic protection.

The total weight of the unit system shall not exceed 9.0 lbs.

The loudspeaker system shall be AMK Innovations model **QSA 615-EPS** .

**Conforms to EIA Standards: RS-276-A, RS-278-B, RS-426-A**

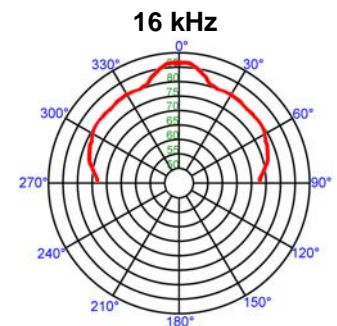
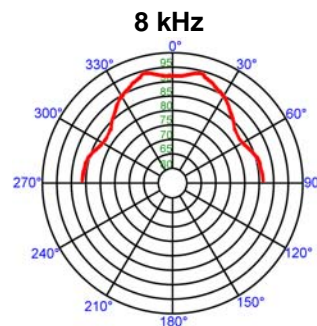
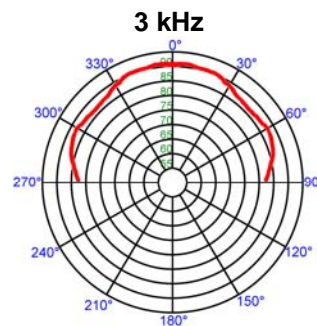
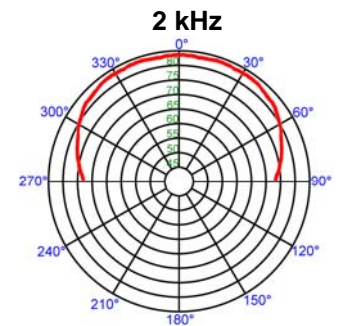
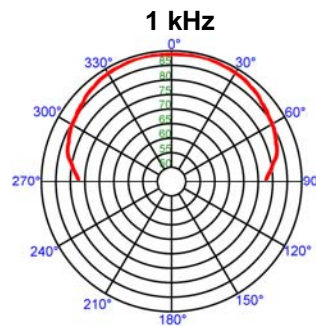
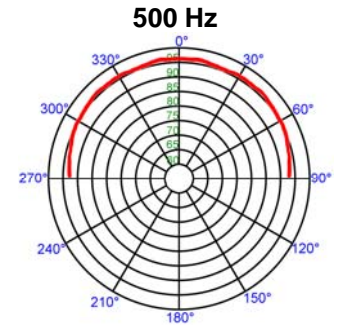
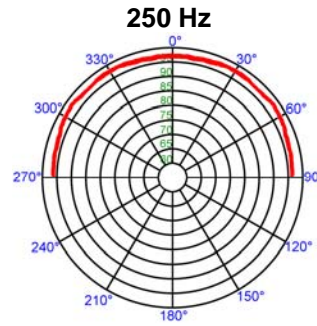

Freq	Deg	Q	DldB
250 Hz	100°	3.8	5.8
500 Hz	96°	4.8	6.8
1 kHz	79°	6.8	8.3
2 kHz	72°	6.7	8.2
3 kHz	66°	9.2	9.6
4 kHz	86°	8.4	9.2
8 kHz	40°	7.1	8.5
16 kHz	16°	15.3	11.8