



12407 Mukilteo Speedway, Ste. 130, Lynnwood, WA 98087  
 Phone: (800) 438-4026 Fax: (877) 721-6107  
 info@amkspeakers.com www.amkspeakers.com

AMK Commercial Series

## PSA 802-CFM (-P)

Self Amplified 8" Coaxial Loudspeaker Assembly



The **AMK PSA802-CFM** powered speakers feature a 30 watt Class D digital design amplifier, with > 75% efficiency for the main speaker. These units are available as single master speakers or sets with an unpowered companion speaker (**PSA802-CFM-P**) The speaker combines high performance, power handling, and a very smooth response.

The loudspeaker driver, CX802, is one of the few transducers in the commercial sound industry that produces and meets the standards of recording studio. Excellent dispersion, wide bandwidth, and a smooth frequency response make this the top choice for today's overhead commercial applications.

There are wide ranges of the application for this unit, especially in educational markets and corporate boardrooms where direct input of the signal from the processor is desired (i.e., projectors, laptops, or any line level device)

### Features:

- \* All metal construction, including baffle
- \* High performance 8" coaxial loudspeaker with wide dispersion
- \* Self powered with 30 watt Class D amplifier
- \* **UL Listed Speaker Enclosure (UL 1480, UL 2043)**

## Innovative Features

Each system includes a renowned AMK Coaxial loudspeaker like those already installed in hundreds of locations

### Easy to install

- All-metal swivel mounting system allows standard installation of speakers without having to align the enclosure to the tile bridge
- This installation procedure is quick and unique to the industry
- Architecturally pleasing white perforated metal grille that uses a unique metal spring system for a "no visible hardware finished look and the ease of a "snap on" installation

### Custom Manufacturing Options

- Custom depth back enclosures are available
- Power supply available internal or external

### Safety

- The use of all-metal attachment parts makes for an overall safer installation
- All-metal swivel prevents breakage of swivel during installation
- All-metal swivel mounting system is not easily compromised by fire

### Sound

- The plenum compatible back enclosure is designed to maximize the performance of this studio quality speaker

## Specifications

<b>Frequency Response</b>	55 Hz - 20 kHz
<b>Voice-coil diameter</b>	1"
<b>Average Beamwidth @ 2 kHz</b>	110 deg.
<b>Magnet Weight</b>	20 oz
<b>Magnet Material</b>	Barium Ferrite
<b>Tweeter</b>	13mm Polyamide Soft Dome
<b>Woofer Cone</b>	Polypropylene
<b>Surround Material</b>	Inverted Rubber
<b>Crossover Frequency</b>	5.5 kHz
<b>Depth of the Enclosure</b>	7 in.
<b>Diameter of the Grille</b>	12.75 in.
<b>Enclosure Mounting</b>	Metal Swivel Clamp

## Amplifier Specifications

<b>Amplification</b>	30 watt Class D design amplifier
<b>Amplifier Efficiency</b>	> 75%
<b>Total Harmonic Distortion</b>	< 0.2%
<b>Signal to Noise Ratio</b>	>95dB
<b>Protection</b>	Protected as to short circuit to supply and ground, as well as minimum current
<b>Controls</b>	Input potentiometer level adjustment

## FREQUENCY RESPONSE

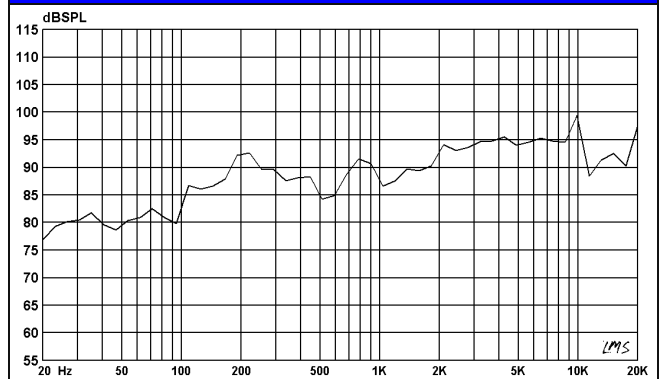

## IMPEDANCE CURVE

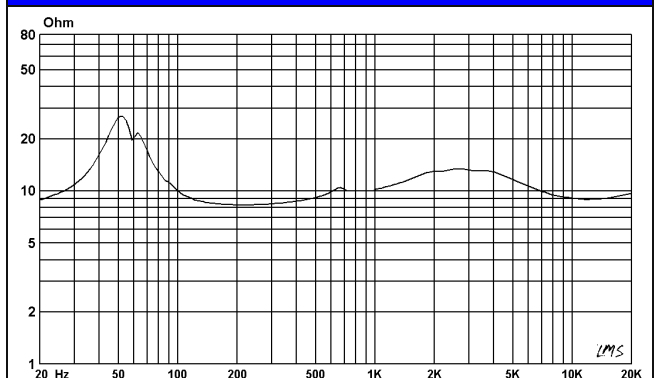

## MODEL CONFIGURATION

Power Supply	External 12Volt w/ Screw Terminal
Power Connection	3.81mm two position Phoenix type connector
Input Connection	3.81mm three position Phoenix type connector
Signal Input	One balanced input
Companion speaker input/output connections (Model No: <b>PSA615-CFM-P</b> )	Screw terminal block connectors
Input Level Adjustment	Internal



(The **PSA615-CFM-P** version comes with the companions speaker as a set of 2 speakers)

**Additional Suffixes**  
 The part numbers listed include the **TB8R** for use with suspended ceilings and speaker Grills  
 For hard lid applications please add either of the following at no additional charge: **-SACSD** for the metal C ring for retro fit applications. **-MD8** For the pre-construction mud ring.

## PSA 802-CFM ILLUSTRATION

Standard Ceiling Tile Bridge

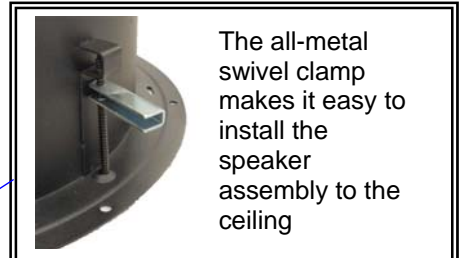
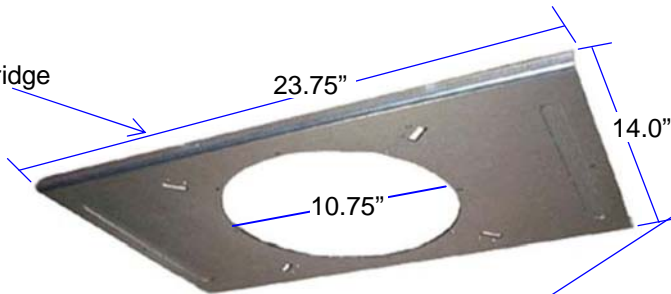

Plenum Compatible Back Enclosure  
**NFPA-70** National Electric Code, **UL 1480** and **UL 2043**, Speakers for Fire Protective Signaling Systems

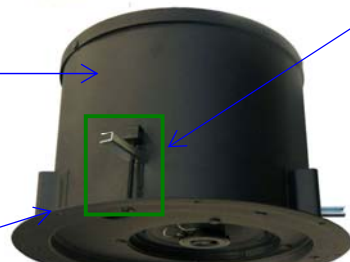

Cardboard Paint Mask (To be discarded after Painting)

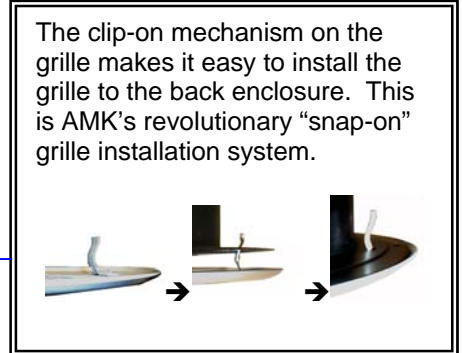

Guide for alignment of enclosure to tile bridge for grille installation



Recessed speaker baffle plate

White Perforated Metal Grille

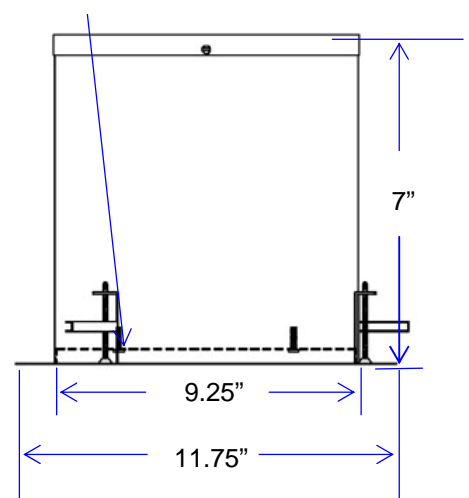
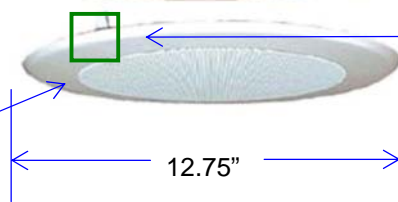

## Architect's & Engineer's Specifications

The powered loudspeaker system shall be **AMK PSA 802-CFM-RVC (-P)**. The speaker shall feature a 30watt Class D design amplifier, with >75% efficiency for the speaker. The powered speaker systems shall be one amplified speaker with option of one other companion speaker.

The loudspeaker system shall have a white metal round grille with a mounting spring tab snaps into the rim of the enclosure.

The powered unit of the system shall have one 3.81mm three position phoenix type connector for balanced audio input. The input level shall be control by the external potentiometer provided with mounting plate. The power connection shall be a 3.81mm two position phoenix type connector. The system shall have 12 volt 1.5 Amps screw mount power supply.

The transducer in the loudspeaker system shall be AMK CX 802 coaxial loudspeaker. The woofer shall have a 40 oz. (1.13 Kg) Barium Ferrite magnet. The two reproducer sections shall be coupled through a built-in capacitor bypass crossover. The crossover frequency shall be at 5.5 kHz. The low frequency reproducer shall have 1" (25.4mm) voice coil and the high frequency reproducer shall have 0.51" (13mm) voice coil.

The system shall have a frequency response of 55 Hz- 20 kHz (+/- 5dB). The power handling shall be 40watts at 8 ohm impedance. The sensitivity shall be 91dB at 1watt / 1meter.

The depth of the enclosures shall be 7 inches. The rim diameter shall be 11.75". The enclosure diameter shall be 9.25". The depth of the enclosures shall not exceed 11.75". The system shall include a tile bridges. The system shall have a metal strap for attachment to the structure for seismic protection.

The total weight of the each unit system shall not exceed 10.0 lbs.

The loudspeaker system shall be AMK Innovations model **PSA 802-CFM-RVC**.

**Conforms to EIA Standards: RS-276-A, RS-278-B, RS-426-A**

## Polar Responses

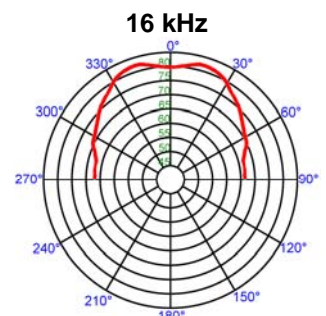
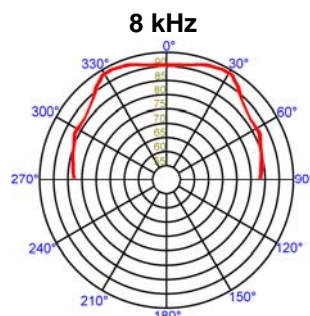
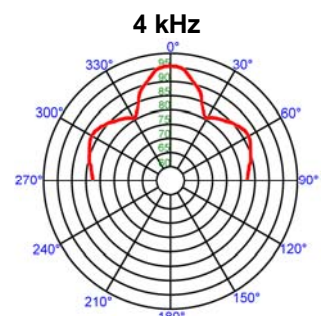
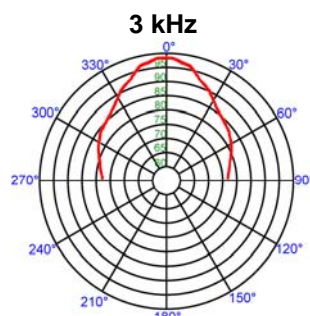
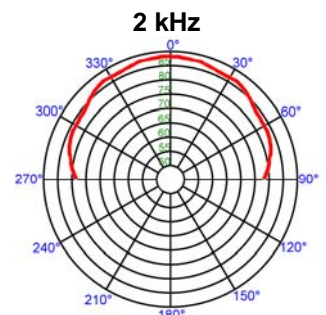
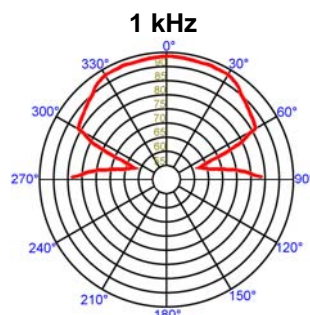
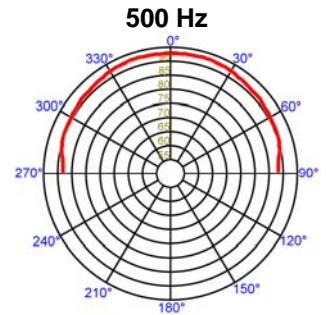
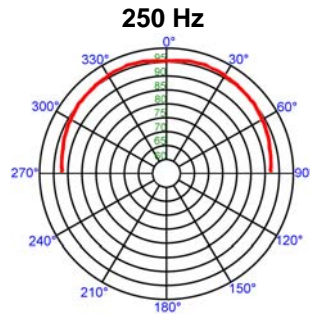

Freq	Deg	Q	DIdB
250 Hz	98°	5.1	7.1
500 Hz	95°	5.7	7.5
1 kHz	55°	9.9	10.0
2 kHz	55°	8.2	9.2
3 kHz	34°	14.4	11.6
4 kHz	25°	18.0	12.6
8 kHz	65°	5.1	7.1
16 kHz	52°	6.9	8.4